

:

:

:

(

(

)

: ☒

: ■

:
-
-
)
(
-

: ■

:
-
"

: ■

()
:

"

"

-

-

-

:



"

:

-

:

-

:

-

:

-

:



:

:



:

:



()

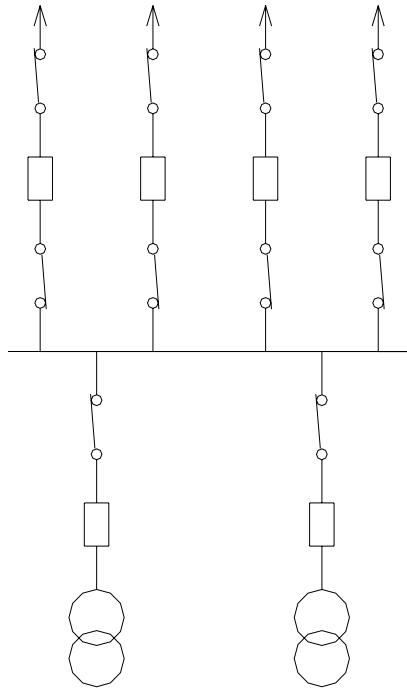

"

"

()

:

-

-

-

-

-

-

:

)

(

-

-

-

-

-

-

:

o

.()

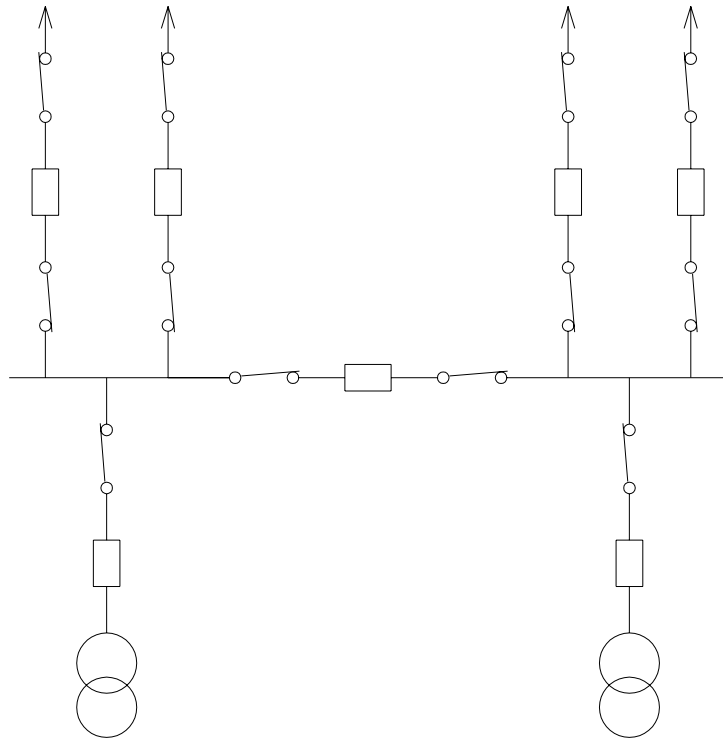

" "

:

○

.()

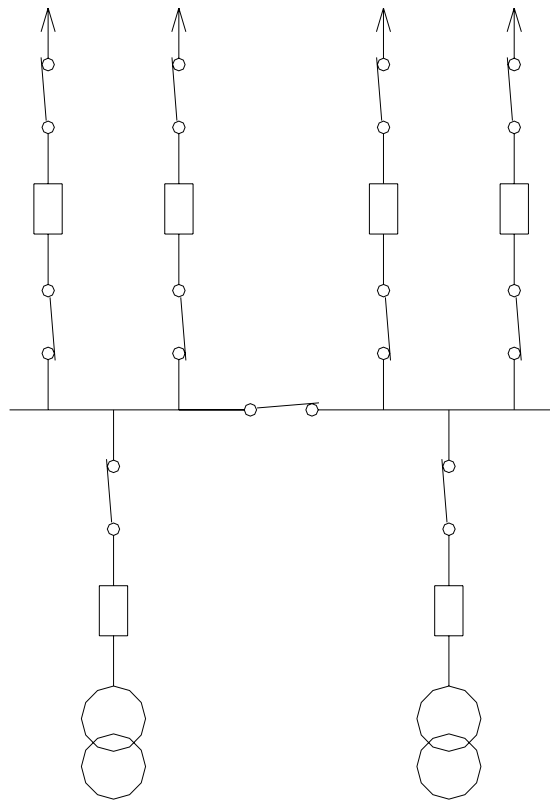

" "

:U

•

U ()

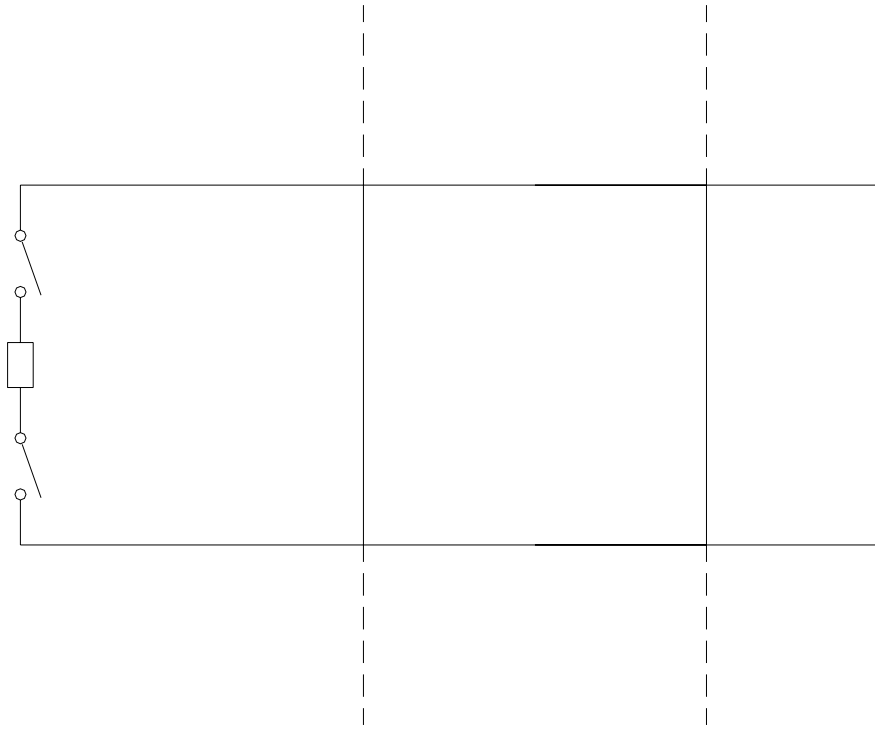

U

"4

"

:

•

.

.

(

)

:

:

○

()

:

By-pass

()

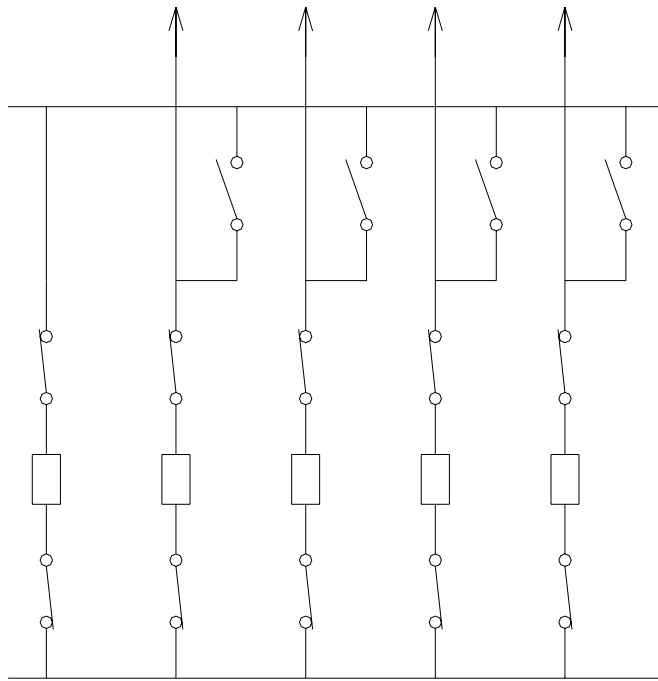

" "

:

○

()

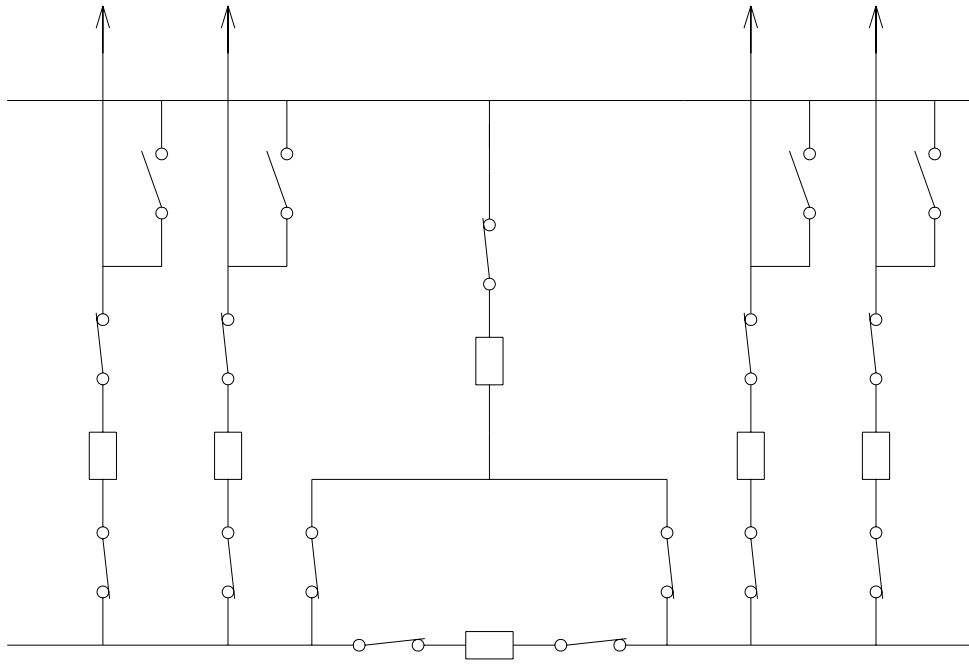

" "

:

○

()

"

.

.

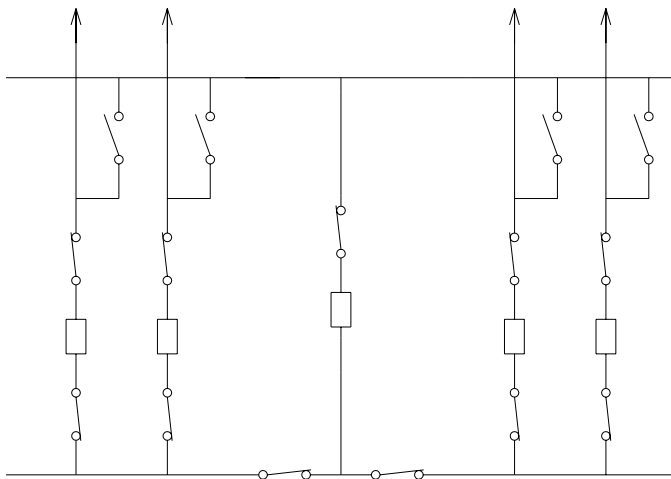

" "

:

•

()

:

-

-

-

-

-

-

-

()

:

-

-

-

-

-

-

.

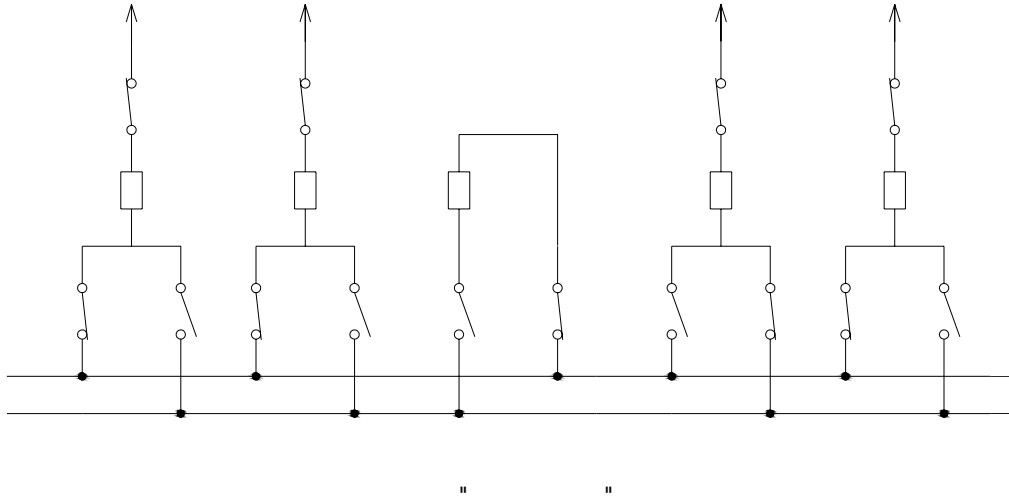

By-pass

pass By-

()

By-pass

By-pass

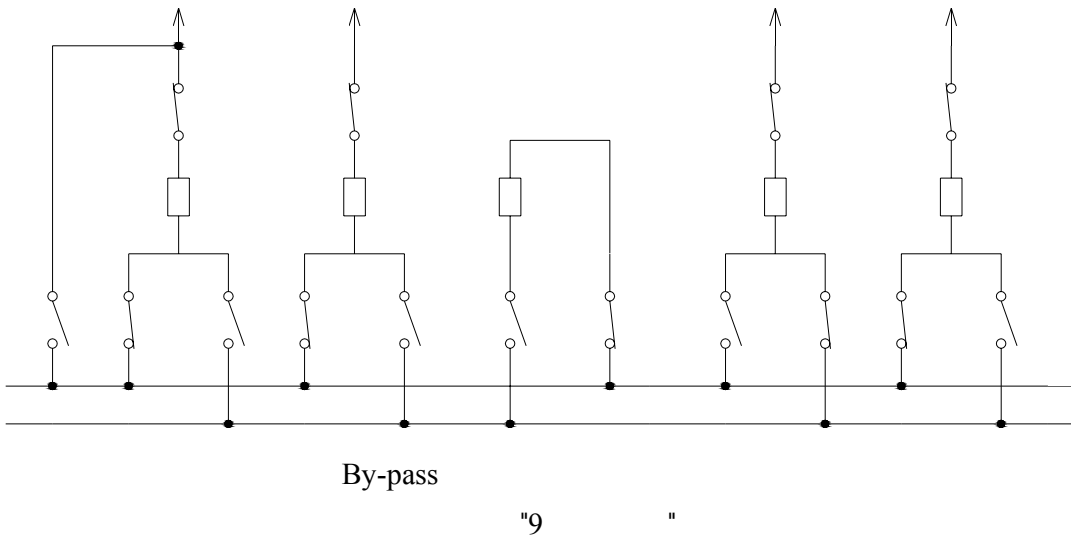

By-pass

"9

"

:



()

By-pass

By-pass

U

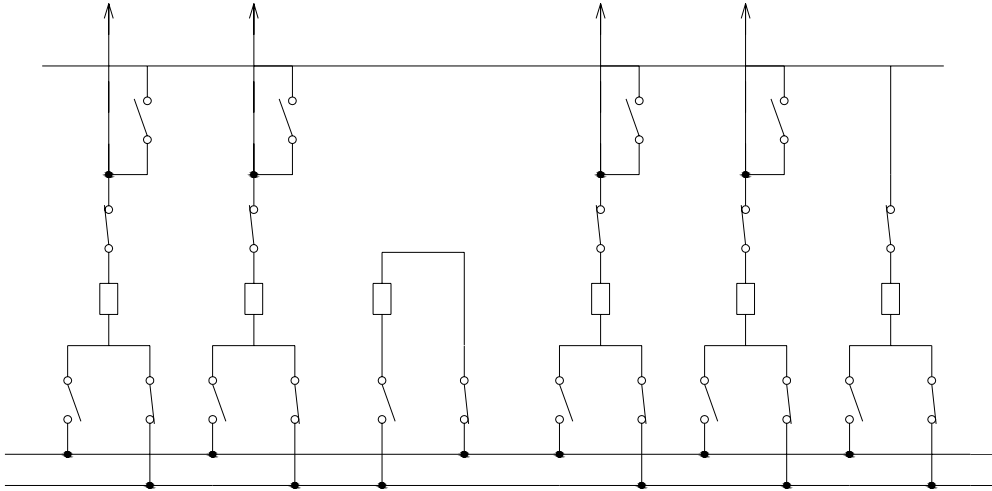

"

"

:



.()

"

:

-
-
-
-
-

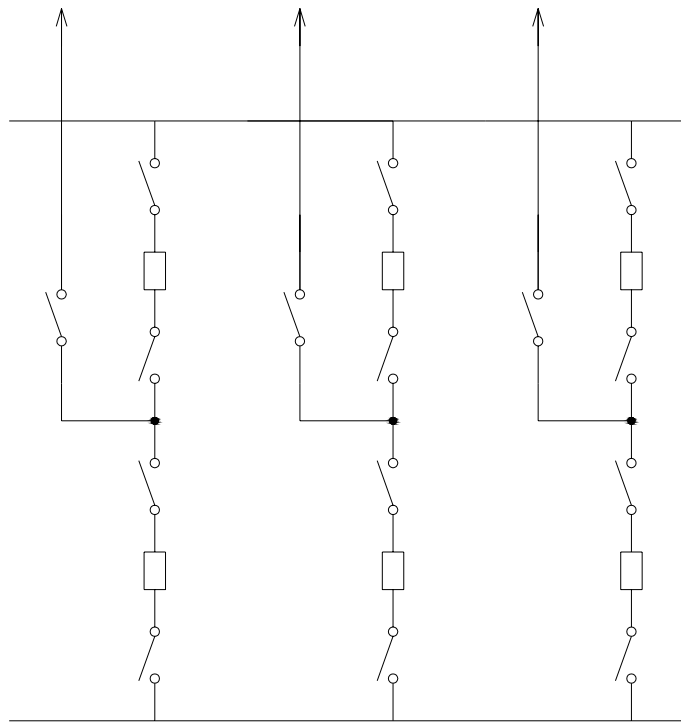

" "

:

()

●

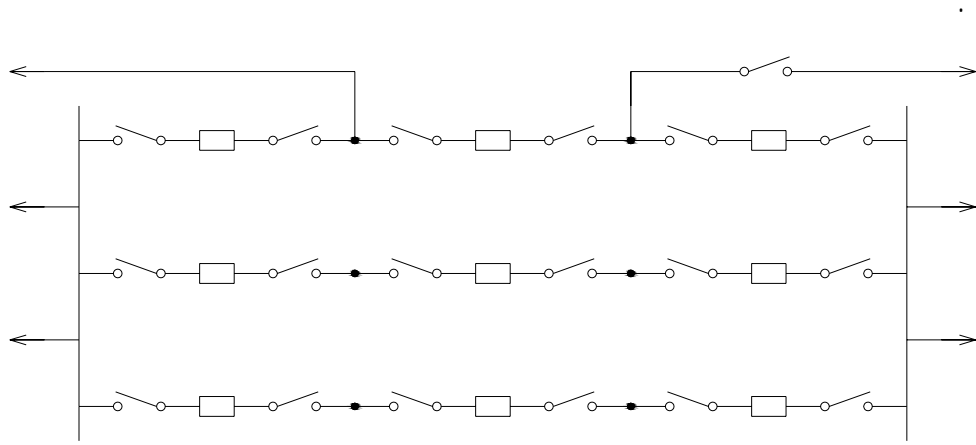

" "

:

-
-
-
-
-
-

:

-
-
-
-

.()

: •

:

:(H Π)

-

()

"

Π

H Π

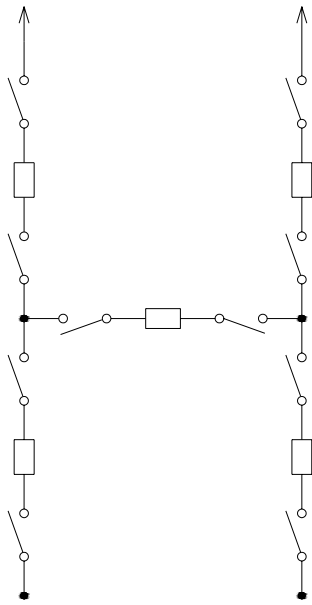

H

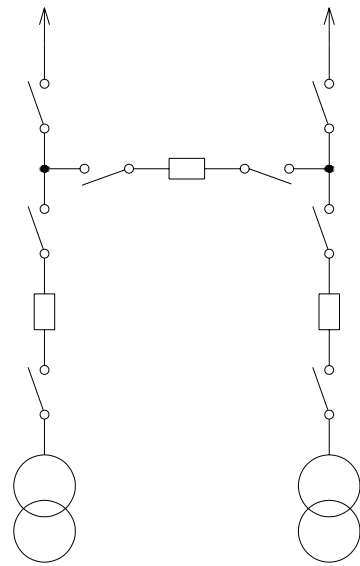

Π

"

"

H Π

Intertrip

Π

Π

()

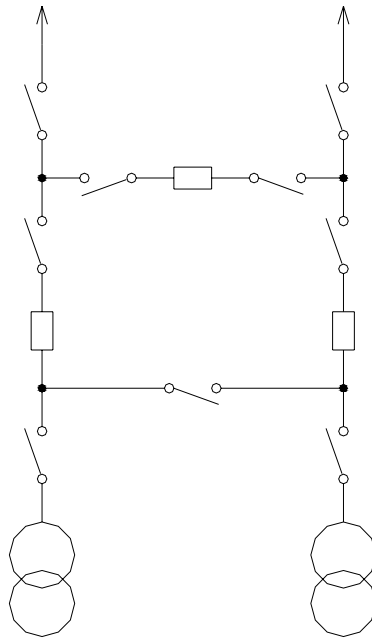

Π

"

"

:

○

()

n4 n3 n2 n1

:

-

-

-

-
-
-
-
-
-
-
-
-
-

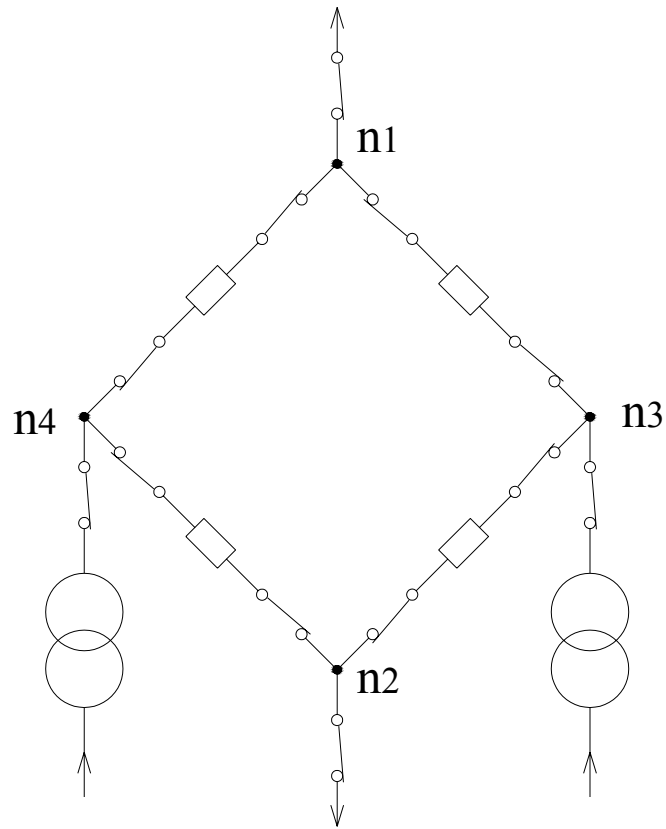

" "

:

•

: $\frac{1}{3}$

○

()

"

$\frac{1}{3}$

()

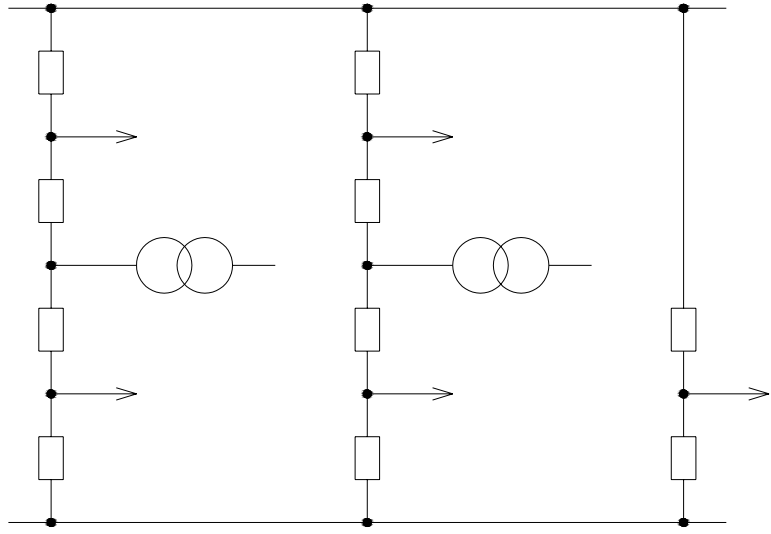

$1\frac{1}{3}$
"

"

:6×9 4×6 ○

() 4×6

$1\frac{1}{3}$

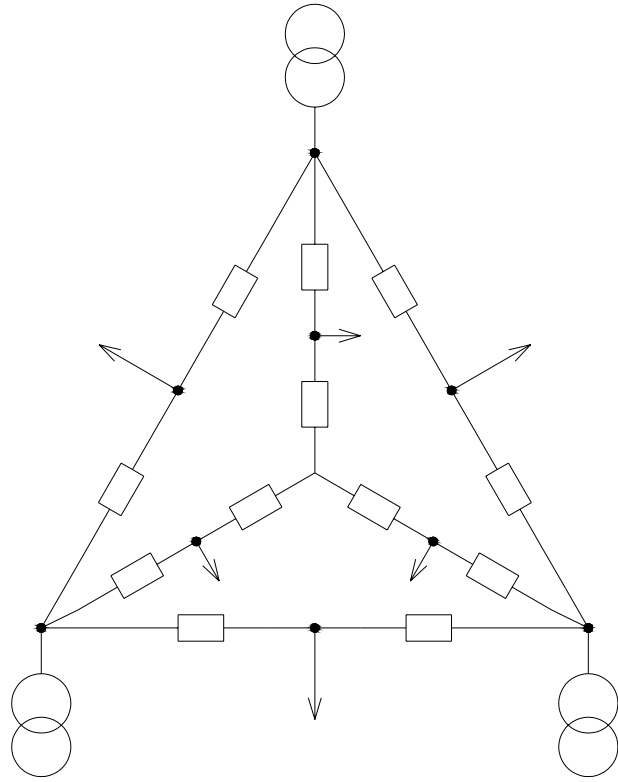

4×6

" "

()

6×9

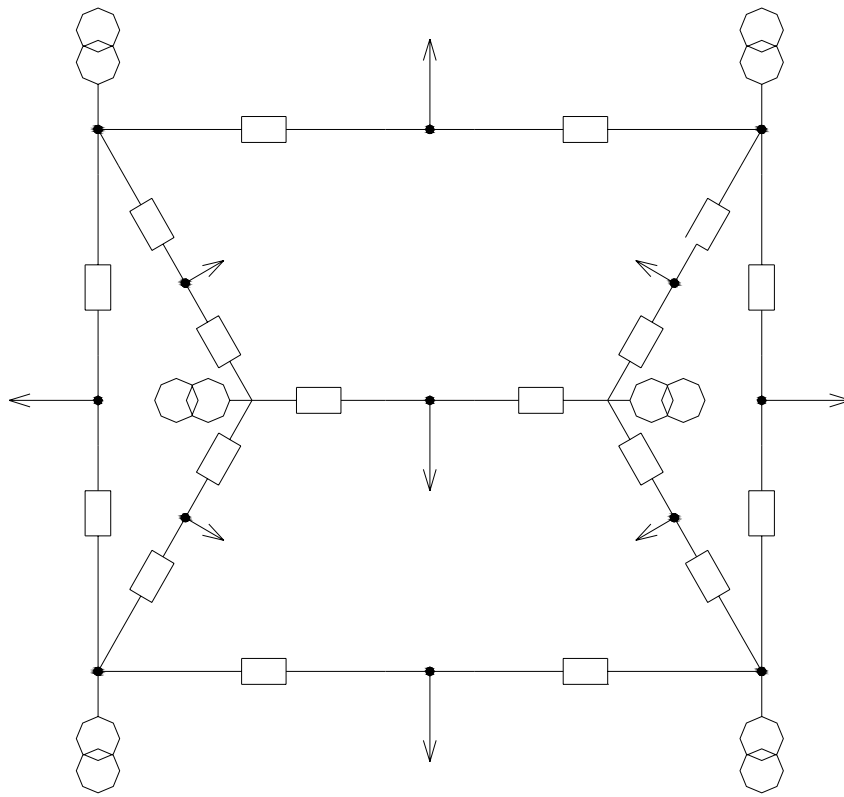

6x9

"

"

:

○

()

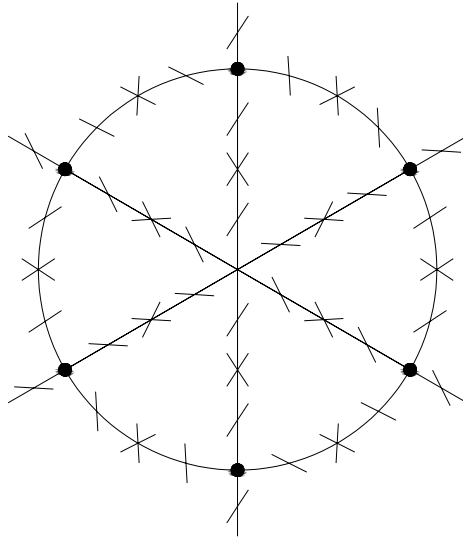

" "

()

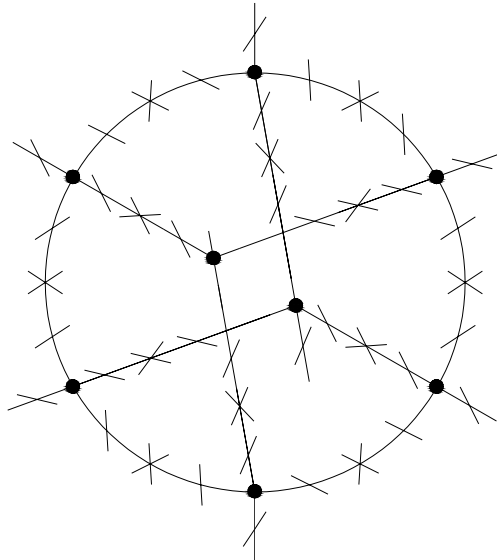

" "

()

$$n + \frac{n}{2}$$

n

n+1

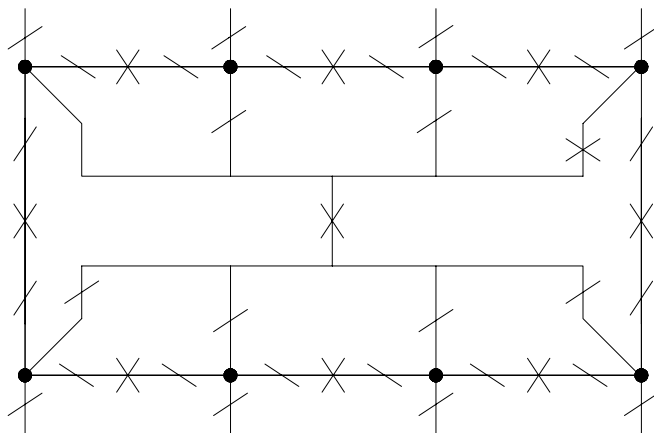

" "

n

()

$$n + \frac{n}{2}$$

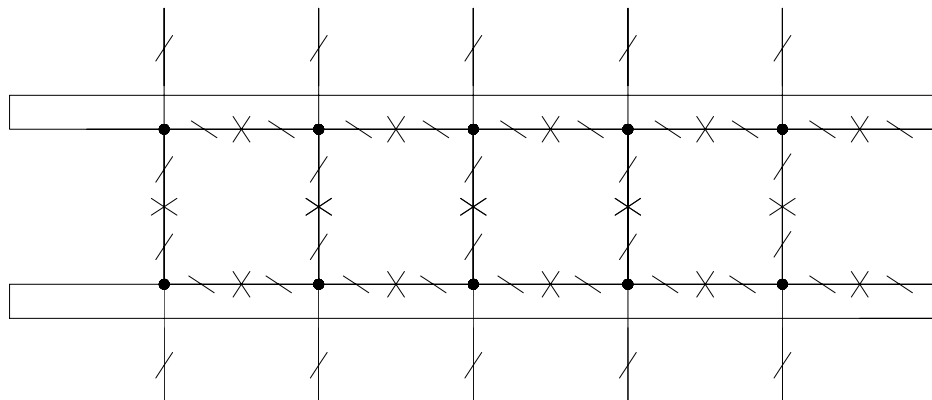

" "

:



:

-
-
-
-
-
-

" "

" "

" " " "

"

()

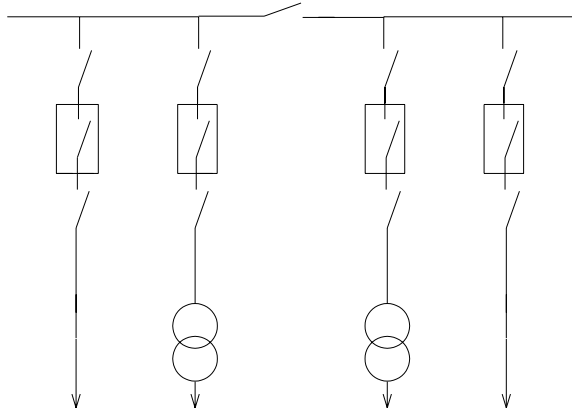

-

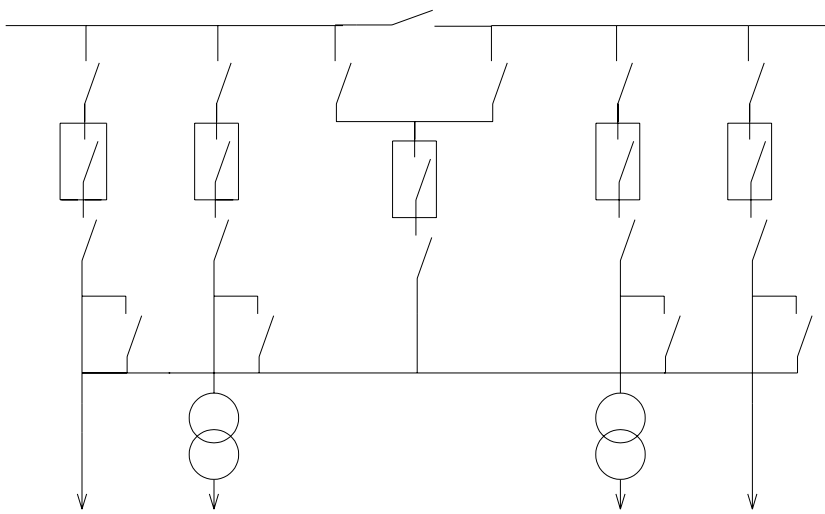

-

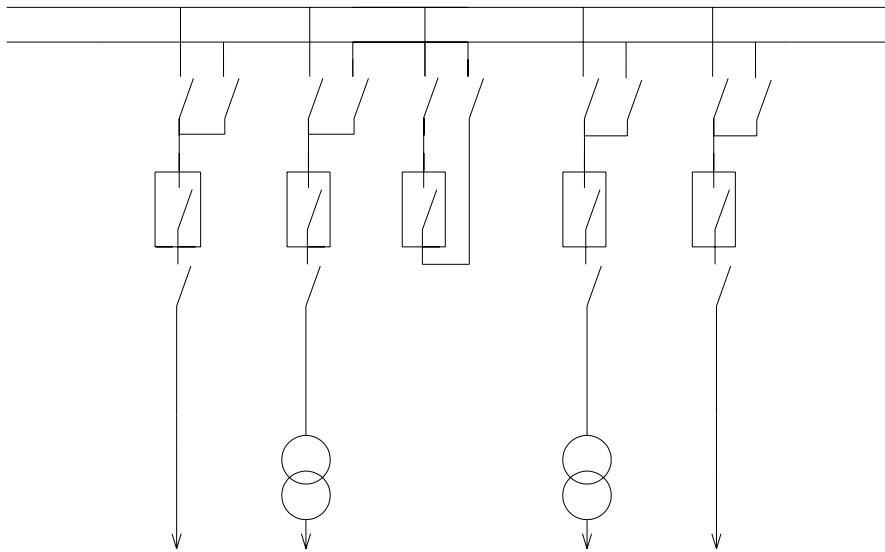

-

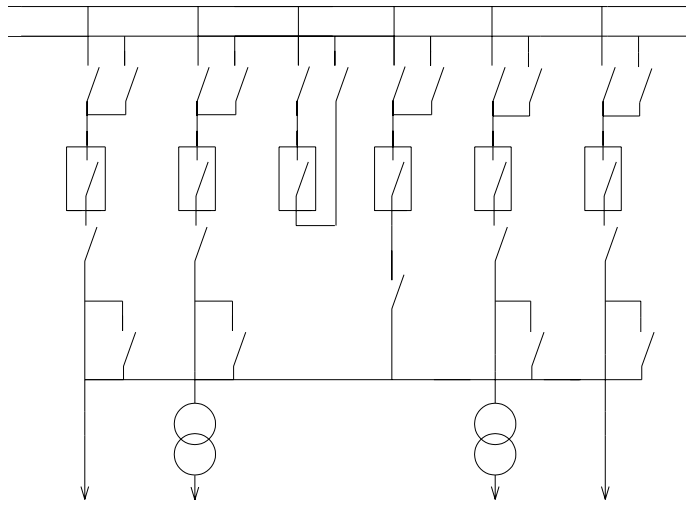

-

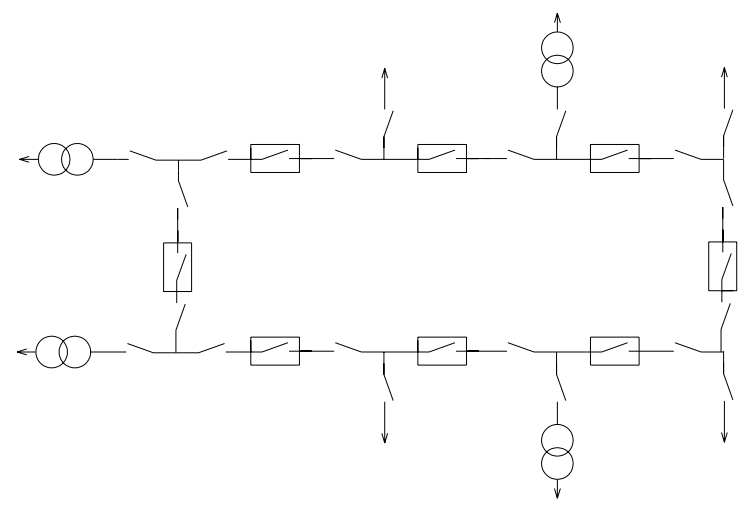

Н -

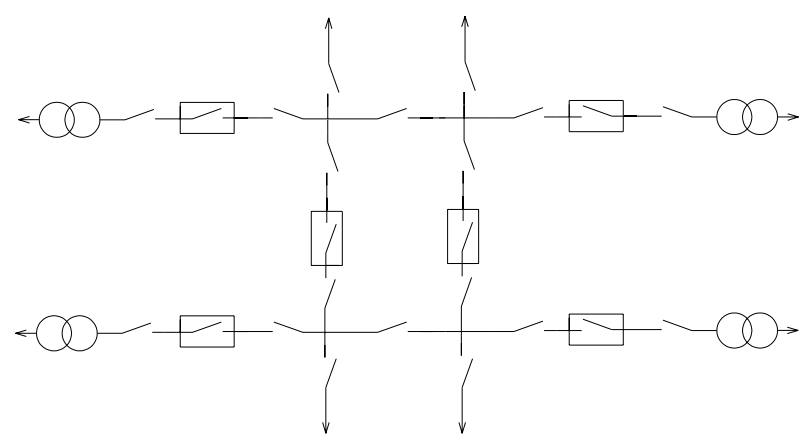

П -

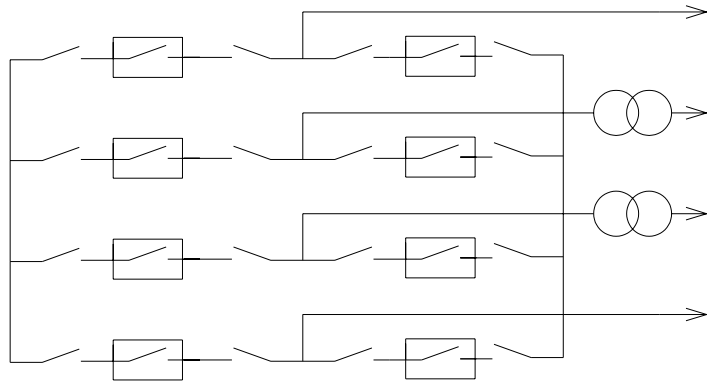
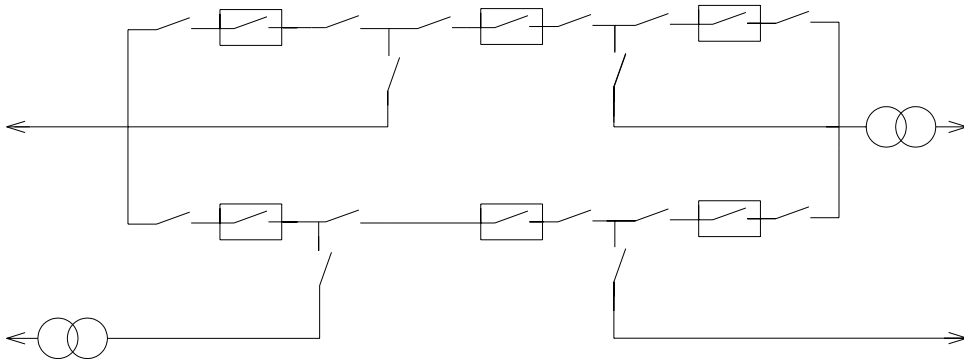
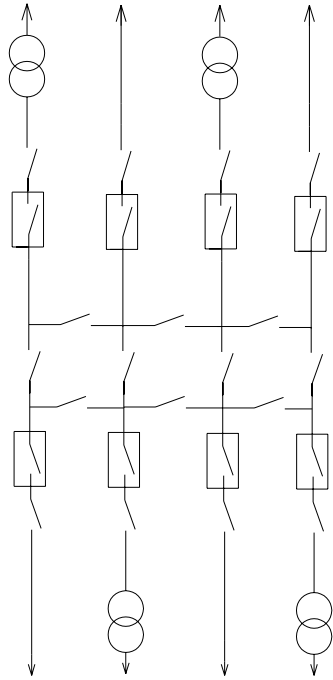

: •

:

-

-

:

()

-

-

Breaker Failare

-

()

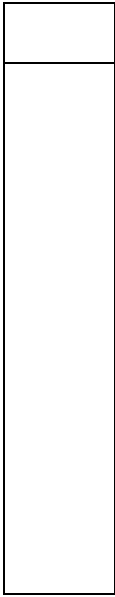

"

"

: •

()

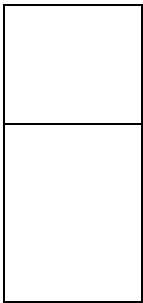

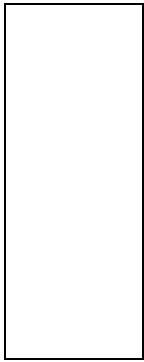

" "

: •

. ()

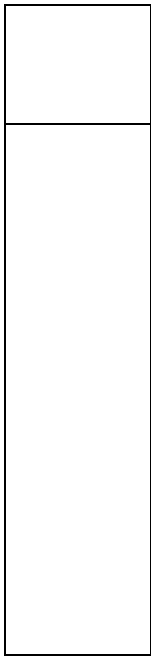

" "

:

•

:

-

-

$$e = e + 0.1e$$

$$e_{av} = \frac{1}{n} \sum_{x=1}^n e_x$$

: e_{av}

: e_u

: u

: e_x

x

: e_x

()

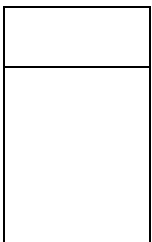

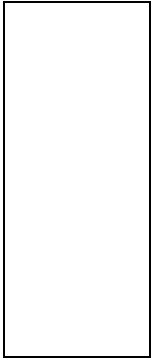

"

"

:

-

()

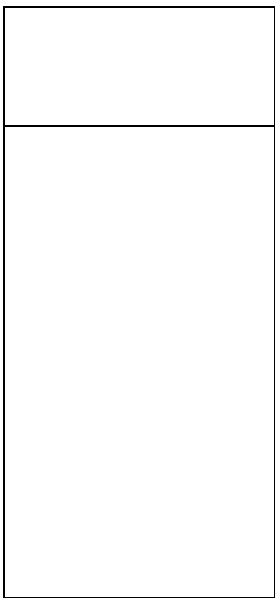

"

"

:

•

:

-
-
-
-
-
-
-
-
-
-

(GIS)

"

:

:

(

-
-
-

:

(

-
-

-

-

:

•

"

"

"

)
()
:
-
-
()
-
-
()
-
(")